

# Plankton Survey System

S. A. Ruberg, H. A. Vanderploeg, J. F. Cavaletto, G. A. Lang, J. R. Liebig, T. C. Miller  
NOAA/Great Lakes Environmental Research Laboratory  
2205 Commonwealth Blvd.  
Ann Arbor, MI 48105

M. Agy  
Cooperative Institute for Limnology and Ecosystems Research  
University of Michigan  
Ann Arbor, MI 48105

*Abstract* – The Plankton Survey System (PSS), developed at the National Oceanic and Atmospheric Administration’s (NOAA) Great Lakes Environmental Research Laboratory (GLERL), has been designed to collect high temporal and spatial resolution marine environmental data in three dimensions. The system has proven effective in providing valuable survey information before, during and after sediment re-suspension events in Lake Michigan in support of GLERL’s NOAA/NSF funded Episodic Events Great Lakes Experiment (EEGLE) program.

The PSS is a towed multi-sensor platform capable of measuring turbidity, chlorophyll *a*, photosynthetically active radiation (PAR), conductivity, temperature, and zooplankton spatial distributions. All sensors are integrated using a serial data interface. All data are geo-referenced and registered with time, depth, and vehicle pitch, roll, and speed information. A deck unit supplies power for the underwater vehicle components and provides interfaces for data collection and system monitoring. System software provides real-time display of all marine environmental measurements and vehicle status.

Zooplankton spatial and individual size distributions are measured using an optical plankton counter (OPC). The OPC measures particle size distributions (0.25 – 14mm) using an LED array and a photodiode receiver. Deflections caused by particles crossing the LED generated light beam (4x20x100 mm) are detected by the receiver and digitized. Present work is focused on moving the OPC beyond use as merely a survey tool to calibrating the instrument using laboratory and field measurements.

Laboratory calibration plans include the use of specified particles to establish a reference and subsequent investigations using live zooplankton samples. A range of issues involving the implications of variations in zooplankton body characteristics on OPC detection threshold, turbidity on OPC signal-to-noise ratio, tow vehicle orientation and vehicle and OPC channel turbulence will also be investigated.

## I. INTRODUCTION

The NOAA/GLERL Plankton Survey System (PSS) provides continuous, high-resolution temporal and spatial measurements in support of the EEGLE project in the southern basin of Lake Michigan [1]. Post-processing of the large data sets supplied by the PSS allows visualization of physical and biological parameters on a large geographic scale.

The GLERL PSS design is based on an existing system developed by C. Taggart, Dalhousie University, Halifax, NS and by W. G. Sprules at the University of Toronto, Ontario [2]. The PSS optical plankton counter (OPC), used for zooplankton counting and sizing in the PSS, was originally developed at the Bedford Institute of Oceanography [3] in the early 1980’s and is now manufactured by Focal Technologies, Inc., Dartmouth, NS. The UT system uses a type 1T OPC with a 0.4x2x25cm measurement beam while GLERL systems utilizes the smaller type 2T system with 0.4x2X10cm measurement area to reduce the likelihood of coincidence counting in fresh water where zooplankton densities are greater.

## II. SYSTEM DESCRIPTION

### A. *The Plankton Survey System*

The NOAA/GLERL PSS is capable of measuring multiple physical and biological parameters and registers all data spatially and temporally. Parameters measured with general specifications include:

#### **OPC-2T**

Zooplankton size, range:	0.25-14 mm
Light attenuation:	0-250
Flow:	0.10-7.9 m/s
Depth/pressure:	0-350 m (0-500psi)

## OS200 CTD (Ocean Sciences, San Diego, CA)

Conductivity:	0.5-65 mS
Temperature:	-2-35 deg C
Depth:	0-3000 m
Fluorometer (Chelsea Mk IV)	
- Chlorophyll <i>a</i>	0.01-100 ug/l
Pitch/Roll:	+/-70 deg
PAR (Biospherical Instruments, San Diego, CA)	
- solar irradiance, max	1.5-2.0E17 quanta/cm2/s

Referencing fig. 1, the OS200 CTD functions as the analog sensor interface while the OPC handles

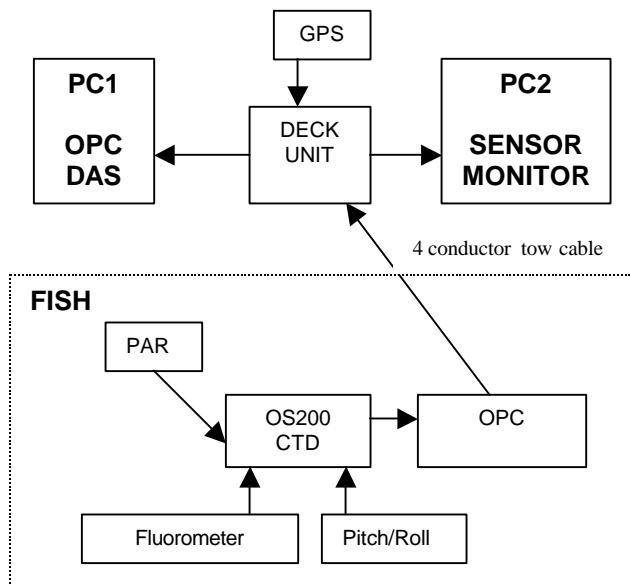

Fig. 1 Simplified block diagram.

data collection and data transmission. The OS200 is designed with a 16-bit analog-to-digital (A/D) converter allowing the addition of sensors in a very straightforward manner through a 6-channel interface. Signals from the pitch, roll, and fluorometer sensors are interfaced with the CTD A/D converter. All data collected by the OS200 are converted to a serial ASCII format and interfaced to the OPC. Serial data is sent from the OS200 to the OPC using frequency shift keyed modulation of a 25kHz carrier frequency to transmit the data over a conductive tow cable to the deck unit on the surface. The data is then demodulated by the deck unit where it is displayed/stored on a laptop PC. The DOS-based LabWindows data acquisition software was designed by Focal Technologies for the OPC. The software provides a histogram display of size-binned zooplankton counts or a real-time display of counts per second and a light attenuation plot. A Win98-based user interface has been developed to display CTD A/D channels such as PAR, chlorophyll fluorescence, and temperature data. All instrumentation is mounted on a 1 meter Endeco/YSI V-Fin.

## B. Optical Plankton Counter (OPC)

Zooplankton spatial and individual size distributions are measured using the OPC. The system has been designed to provide real-time measurements of zooplankton size and density at a spatial resolution not possible with net sampling. The measurement technique implemented in the OPC is based on particle perturbations of a light beam where previous automated zooplankton detection systems were based on the Coulter counter principle [4]. The instrument counts and sizes particles (0.25 – 14mm) using an LED array and a photodiode receiver. Deflections caused by particles crossing the LED generated light beam (0.4x10cm) are detected by the photodiode, passed through an inverting amplifier, and digitized using a 12-bit A/D converter (0–4095 voltage levels). This deflection voltage, or digital size (DS) [5], is converted to an equivalent spherical diameter (ESD) using a calibration table that resides in the PC data acquisition system software. The equation governing the conversion from DS to ESD can be modified to reflect specific zooplankton body shape characteristics. A volumetric measurement of zooplankton concentrations is calculated using the flow rate from a General Oceanics mechanical flow meter mounted external to the measurement channel.

## III. SYSTEM OPERATION

The PSS hardware and software have been used on 25 separate cruises in Lake Michigan from 1998-2000, covering 130 transects, and has generated close to 200 data sets during the southern Lake Michigan EEGLE project. PSS data sets were collected along transects (fig. 2) at Racine, Chicago, Gary, New Buffalo, St. Joseph and Muskegon and compared to discrete plankton net tows collected at depths of 15, 45, and 80-110 meters along the transect.

The PSS was installed and operated on several different research vessels of varying size during the EEGLE project. The system's small size (1 meter v-fin) and weight (156 lbs.) allow for ease of transport and installation. Data acquisition and monitoring of data collection has been straight-forward and reliable. System setup and operation is achieved with windows-based data acquisition and monitoring programs and the entry of data acquisition commands through a DOS terminal interface to the OS-200 CTD.

The PSS is operated at 3-5 kts. in a tow-yo fashion using a winch to pay out cable until a specific depth is achieved and the instrument is then retrieved to the surface. This method results in a sinusoidal depth profile as the instrument package is towed along a specified heading. OPC data collection was observed to be affected by v-fin pitch angle and water turbidity. When compared to zooplankton net data, the OPC generally provides higher estimates of zooplankton population numbers and biomass. These factors will be examined in greater detail below.

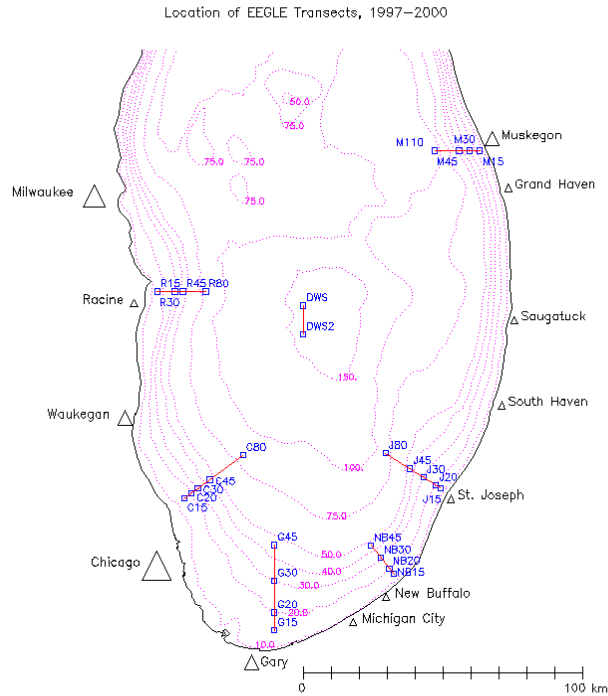

Fig. 2. EEGLE Study Area: Southern Lake Michigan

### A. Pitch Angle

A difference in zooplankton counts on the upcast vs. the downcast was observed during data collection. In some cases 20% fewer counts are registered on the upcast when the v-fin is traveling at higher speed. The greater pitch angle in relation to the v-fin trajectory angle causes the OPC flow to shear as the instrument package is towed. A potential solution to this problem would be to provide an independent control of the OPC pitch to maximize flow in the channel.

Flow measurement could also contribute to the difference. This parameter is currently measured external to the OPC channel. In-channel flow measurement is currently under development by Focal Technologies as it will provide a more reliable estimate for volumetric calculations.

### B. Turbidity effects

OPC counts were observed to decrease at the very high turbidity levels seen during Lake Michigan sediment plume events. Based on laboratory analysis of water samples collected during field operations and on transmissometer readings, the counts appear to be affected when total suspended matter exceeds 20 mg/l. This corresponds to OPC light attenuation readings of LA > 195. As LA approaches a reading of 220 (~30 mg/l TSM), OPC counts approach zero.

Zooplankton net data collected during this transect appear to be independent of turbidity.

The OPC was modified to obtain higher output power from the LED array to reduce the effects of high turbidity on data collection. While the OPC has been operated in plume events with elevated TSM levels since this modification, data has not been collected during a sediment re-suspension event with TSM levels exceeding 20 mg/l.

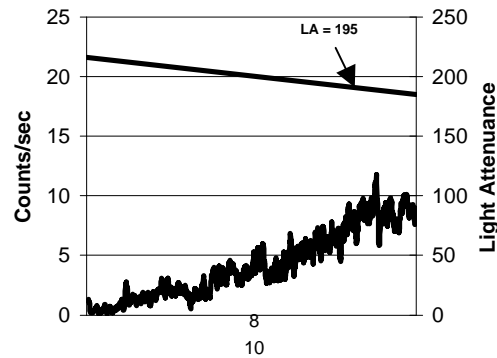

Fig. 3. Zooplankton Counts and Turbidity

### C. OPC and Zooplankton Net Data

Zooplankton net tows were collected by vertical hauls of a metered 153µm mesh zooplankton net (0.5m diameter) from two meters above the bottom to the surface. In the laboratory, at least 600 animals were counted and identified for each replicate net tow. A volumetric calculation of population density and biomass obtained from OPC counts, size and flow meter data on the final upcast of the transect at the 45m St. Joseph station is plotted with zooplankton net data in figs. 4 and 5.

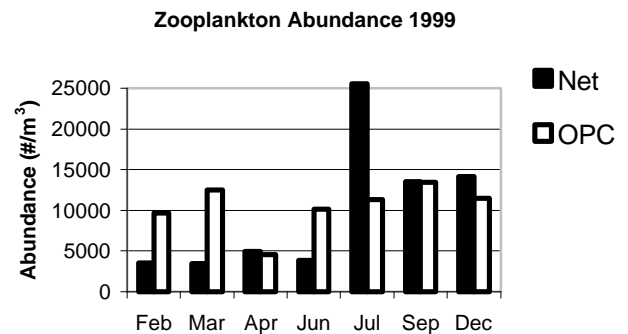

Fig. 4. Zooplankton Abundance – OPC and Nets

In general, the OPC resulted in significantly higher estimates than net tows for zooplankton counts and biomass in the winter/spring months and, with exception of July, closer correlation in the latter part of the year. There are a number of variables that can affect the outcome of accurate measurements when using the OPC such as coincidence counting [6] and v-fin turbulence effects including those already discussed. Likewise the traditional method of data collection using the plankton net tow can present uncertainty

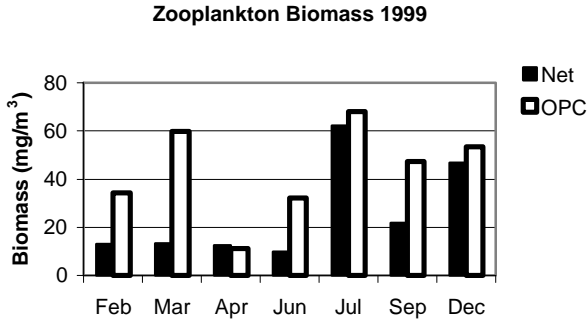

Fig. 5. Biomass – OPC and Nets

in obtaining accurate measurements due to sample extrusion and net clogging. In the case of the 153µm net used for this inter-comparison, it is possible that zooplankton close to the lower edge of the OPC detection range of 250µm have a small enough body diameter to be pushed through the net mesh. Since many freshwater copepods have a body length to diameter ratio of 3:1, zooplankton in the <400µm ESD size range could be counted by the OPC but be extruded through the sampling net. In the latter part of the year, individual zooplankton may be larger in size and not as easily extruded through the net.

### V. DATA POST-PROCESSING

Raw PSS data is converted into two file types for further analysis. The "text" file contains individual zooplankton lengths and weights per half second of PSS tow, and is useful in size-frequency analyses. The "chart" file contains the same information, but is first binned into three size categories (e.g. 0.25-0.5mm, 0.5-1.0mm, 1.0-4.0mm), and is useful in community structure analyses. Also included in both file types are the GPS coordinates, OPC depth, flow rate, and measures of light attenuation, water temperature, chlorophyll fluorescence, and (more recently) PAR. IDL (Interactive Data Language, www.rsinc.com) programs were developed to read either "text" file or "chart" file PSS data, perform all necessary conversions and analyses, and generate various products. These products include time series of PSS depth, flow rate and pitch and roll, as well as spatial distributions of PSS depth, fluorescence, water temperature, light attenuation, PAR, zooplankton counts and zooplankton biomass. In addition, a nearest neighbor technique was used to contour the above parameters as functions of depth and distance from shore (figs. 7 and 8).

### VI. CONCLUSION

High resolution temporal and spatial data collection using the PSS in conjunction with a visualization approach to data post-processing provides valuable large scale observations of marine environmental systems. Towing the multi-sensor system during coastal sediment plume events (fig. 6) has provided insight in to the physical and biological characteristics of this episodic event in southern Lake Michigan and resulted in additional research projects.

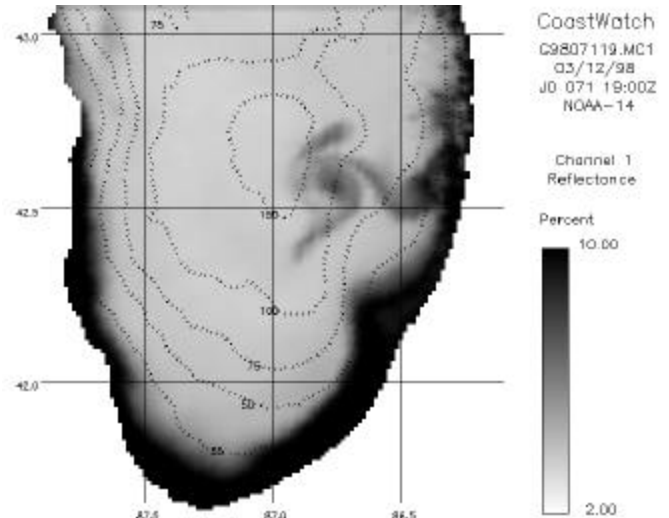

Fig. 6. Sediment Re-suspension Event

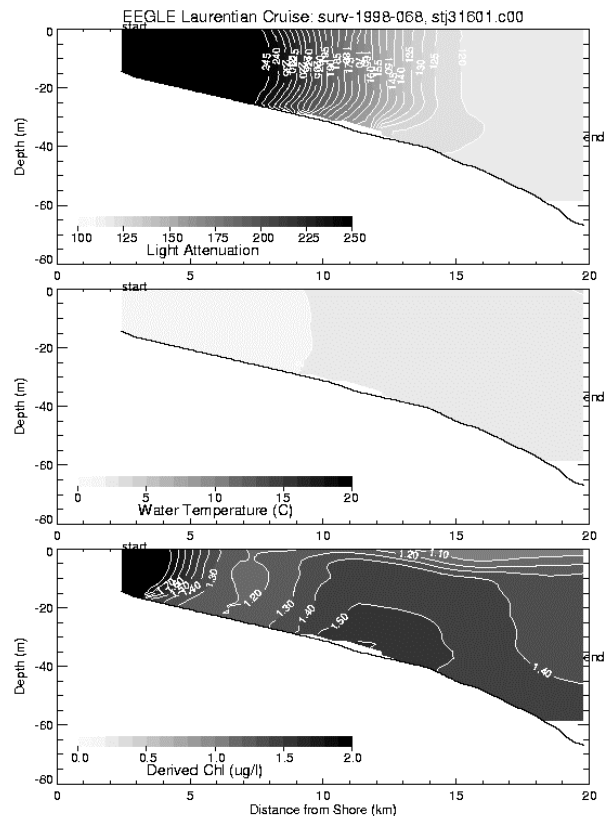

Fig. 7. St. Joseph, MI Transect – March 1998

During a transect in the southeastern portion of Lake Michigan at St. Joseph, MI, the PSS provided information about the geographic location and depth of the plume boundary using OPC light attenuation as an indicator of suspended sediment variability (fig. 7). As distance increases along the transect the light attenuation reading drops to a lower reading indicative of low turbidity. In addition, fig.7 shows water temperature and chlorophyll readings for this transect. Contour plots of OPC zooplankton abundance and biomass data collected along the same St. Joseph, MI transect in late summer of 1998 are shown in fig. 8. Zooplankton abundance and biomass can be seen to peak at the mid-depth thermocline. The OPC has also proven valuable in providing an indication of zooplankton size class variability with depth along the transect.

While the PSS is providing valuable insight into the physical and biological structure of Great Lakes marine systems, there is much work remaining to understand the strengths and limitations of zooplankton data collection using the OPC.

## REFERENCES

- [1] Eadie, B.J., D.J. Schwab, G.A. Leshkevich, T.H. Johengen, R.A. Assel, N. Hawley, R.E. Holland, M.B. Lansing, P. Lavrentyev, G.S. Miller, N.R. Morehead, J.A. Robbins, and P.L. Van Hoof. Recurrent Coastal Plume in Southern Lake Michigan. 1996. EOS 77:337-338.
- [2] Sprules, W.G., E.H. Jin, A.W. Herman, J.D. Stockwell. 1998. Calibration of an optical plankton counter for use in fresh water. Limnology. Oceanog. ,43(4), 726-733.
- [3] A.W Herman. 1992. Design and Calibration of a new optical plankton counter capable of sizing small zooplankton. Deep-Sea Research, Vol. 39, No. 3/4, 395-415.
- [4] W.H. Coulter. 1957. High speed automatic blood cell counter and cell size analyzer, Proceedings of the National Electronics Conference, 1034-1042.
- [5] Focal Technologies Optical Plankton Counter User's Guide, 1996. Section 2.0, p.2-3.
- [6] Focal Technologies Optical Plankton Counter User's Guide, 1996. Section 5.3, p.16.

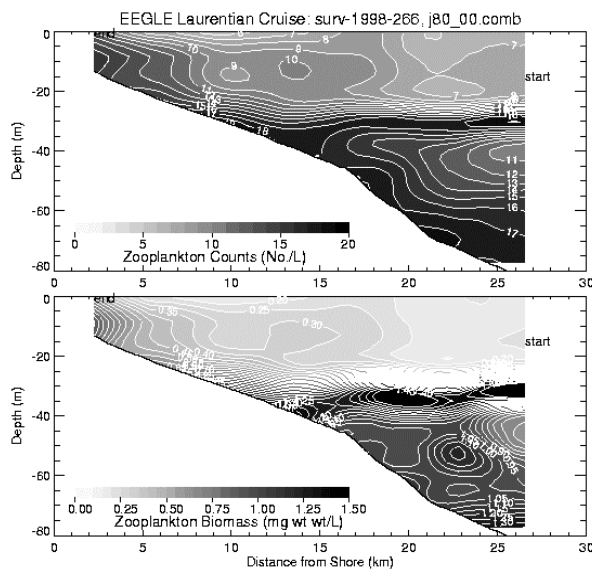

Fig. 8. Zooplankton Abundance and Biomass – Sept. 1998

## ACKNOWLEDGEMENTS

This is GLERL contribution no.1211.